

PLANS TECHNIQUE ET RESERVATION PORTE ALUMINIUM VITREE

SOMMAIRE

Plan de réservation	11
Planche profils	12
Dormant double rainure, avec cornière d'habillage 25,5 x 8 pose en applique intérieure avec iso 120 mm	12
Dormant monobloc aile de 15,5 mm, pose en applique intérieure, avec iso 120 mm	13
Dormant standard aile de 15,5 mm, coupes sur fixe et imposte en dormant, iso 120 mm	14
Dormant double rainure, pose en feuillure	15
Dormant double rainure, pose en tunnel	15
Dormant à recouvrement 43 mm, pose sur dormant existant	16
Dormant double rainure, ouverture 90°	16

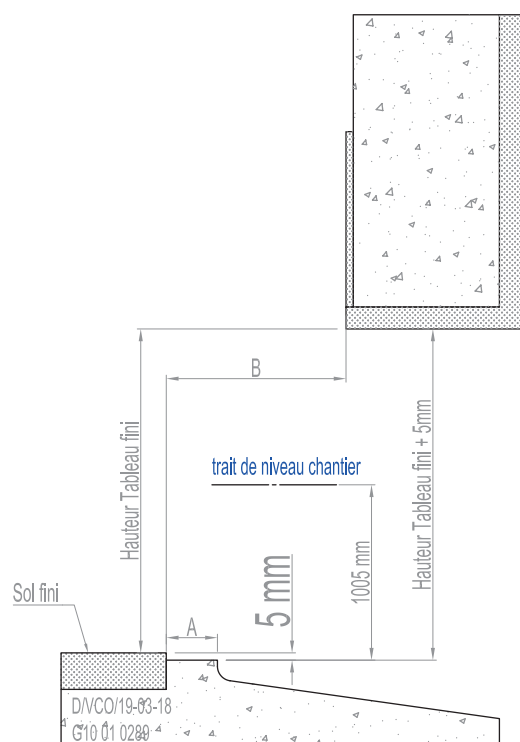

PLAN DE RÉSERVATION

ÉPAISSEUR D'ISOLATION	CÔTES EN MM	
	A	B
70	50	60
100	50	95
120	50	115
140	50	135
160	50	155
180	50	175
200	50	195

Planche profils

Gamme Alu grand vitrage

Dormant standard monobloc

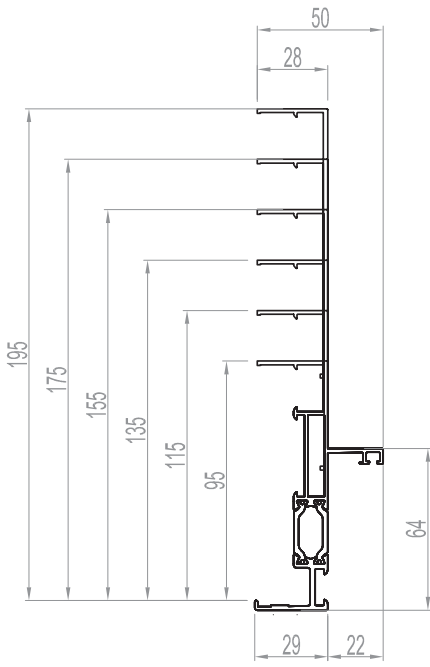

Traverse dormant standard monobloc

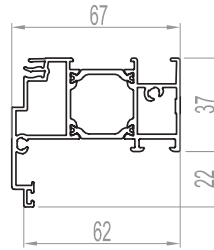

Profil ouvrant

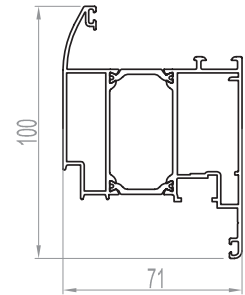

Montant ou traverse intermédiaire

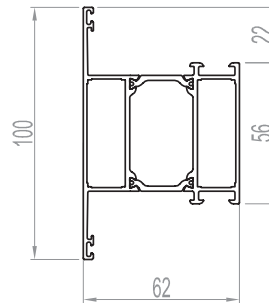

Traverse ouvrant

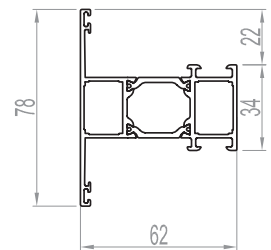

Dormant double rainure

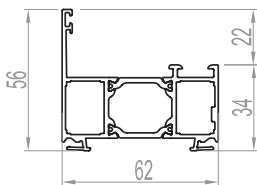

Seuil

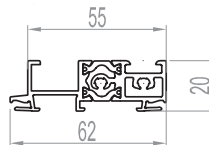

Dormant à recouvrement

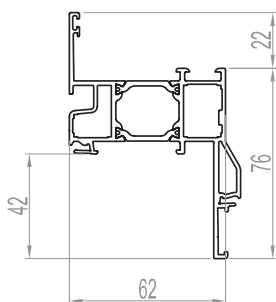

Cornières intérieures compatibles avec dormant à recouvrement

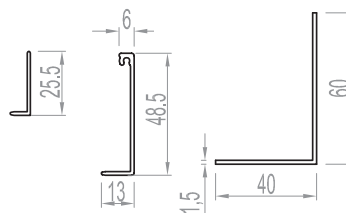
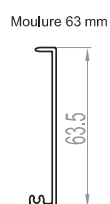
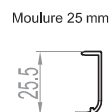

Habillages

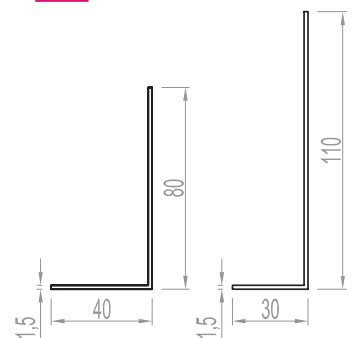

Dormant double rainure

Gamme Alu grand vitrage

Plan neuf
Pose en applique sans tapée

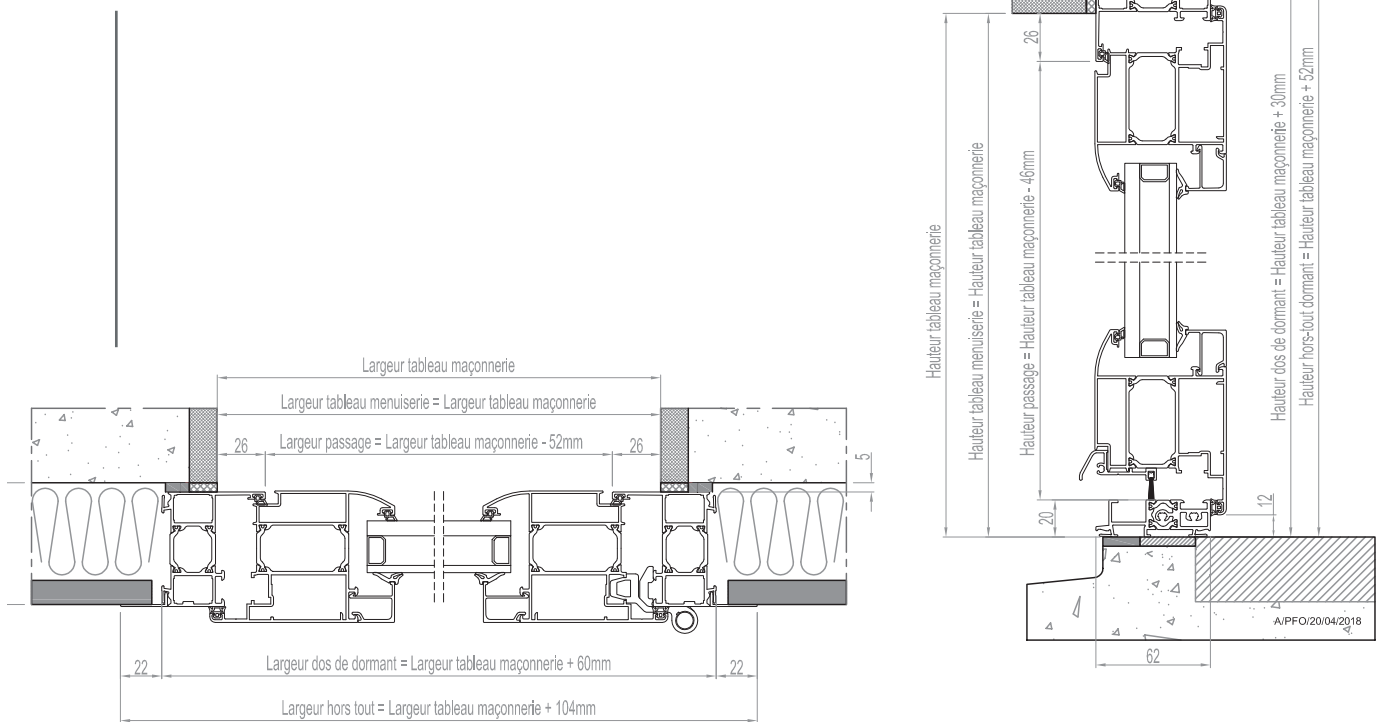

Dormant standard

Gamme Alu grand vitrage

Plan neuf
Pose en applique avec tapée iso 120 mm

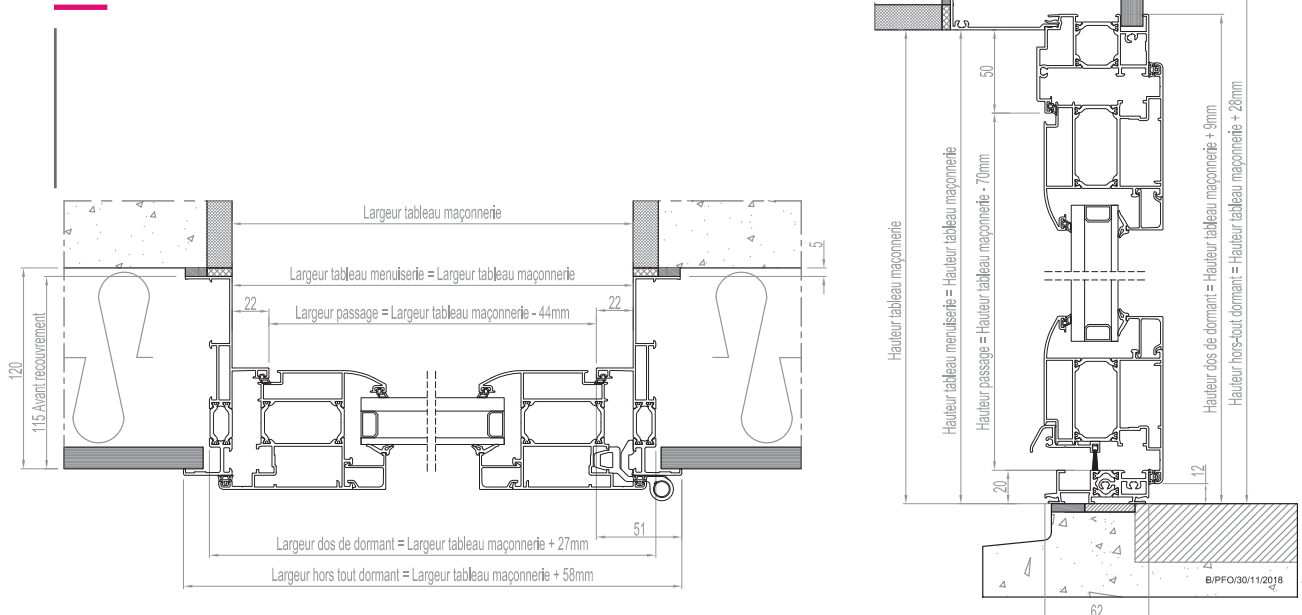

Dormant standard iso 120 mm

Gamme Alu grand vitrage

Coupe horizontale sur fixe en dormant

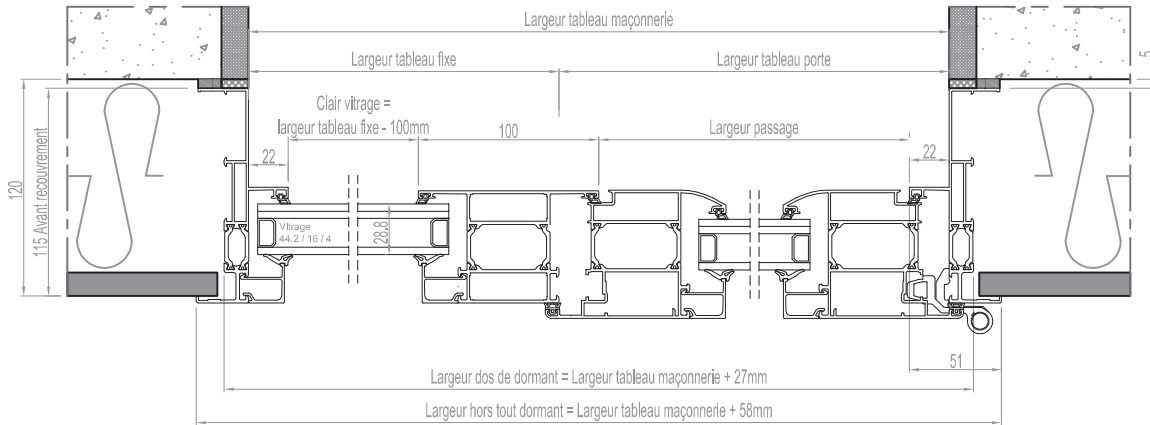

Coupe verticale sur fixe en dormant

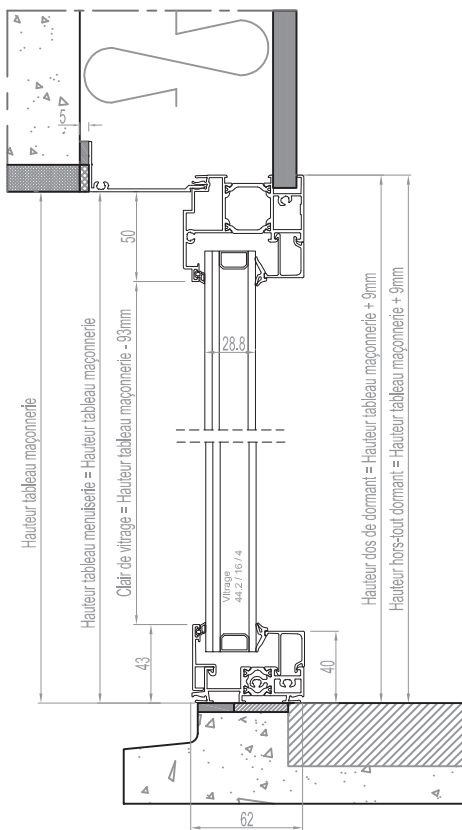

Coupe verticale sur imposte

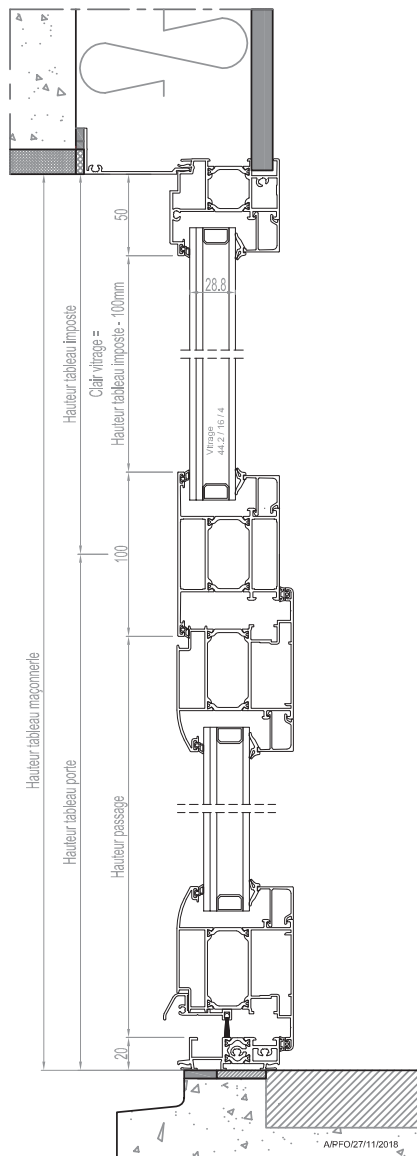

Dormant double rainure

Gamme Alu grand vitrage

Pose en feuillure

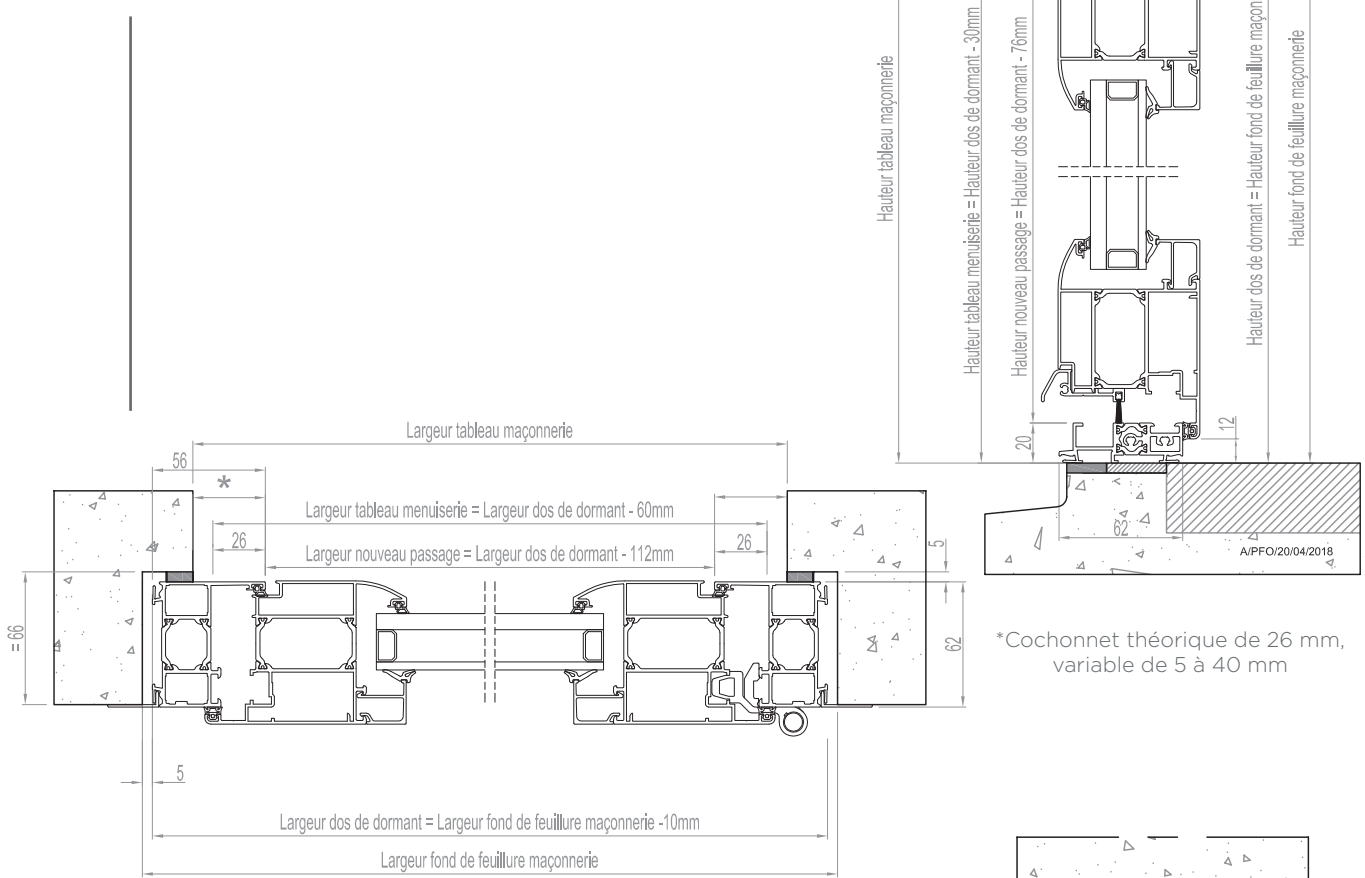

Pose en tunnel

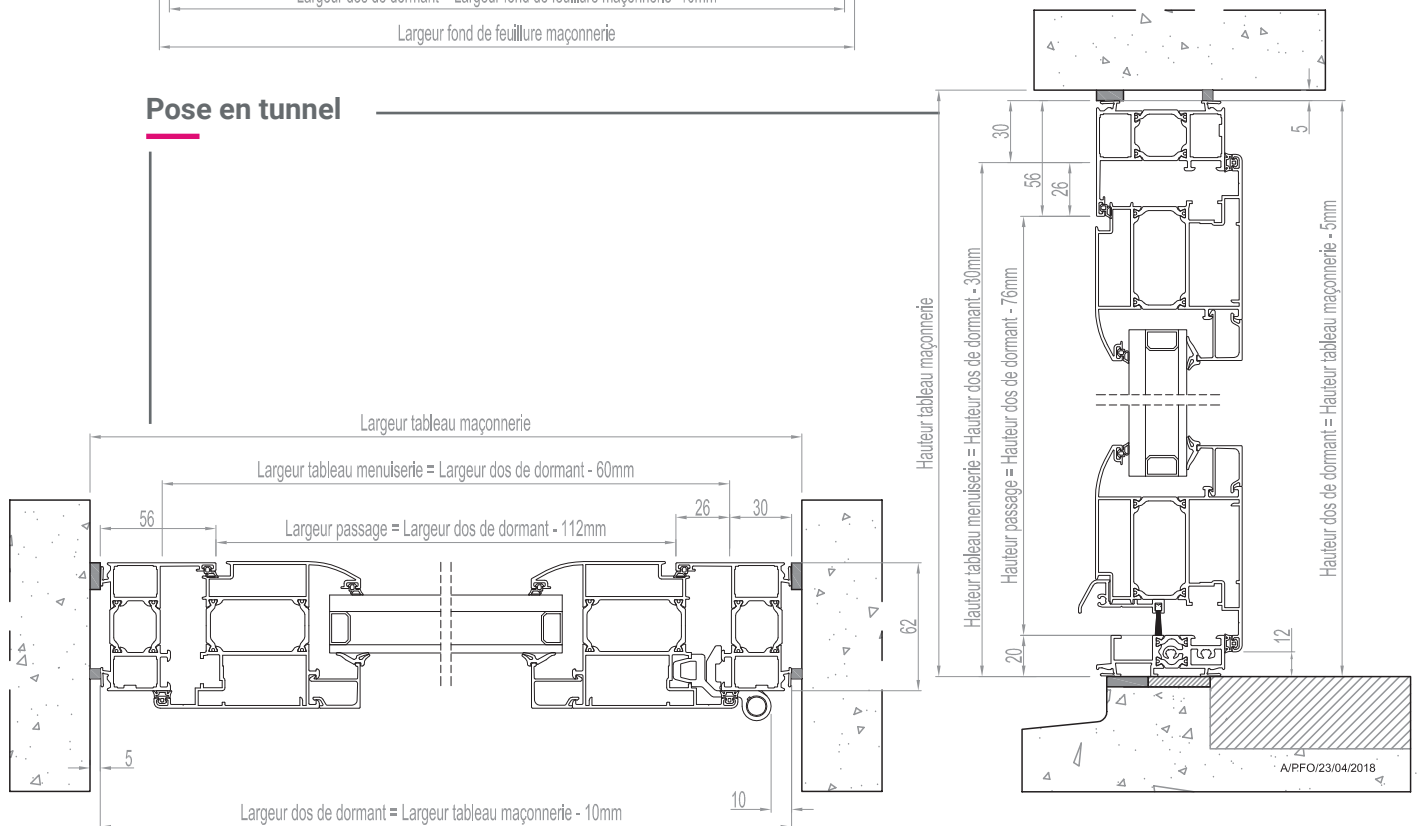

Dormant à recouvrement 43 mm

Gamme Alu grand vitrage

Pose sur dormant existant

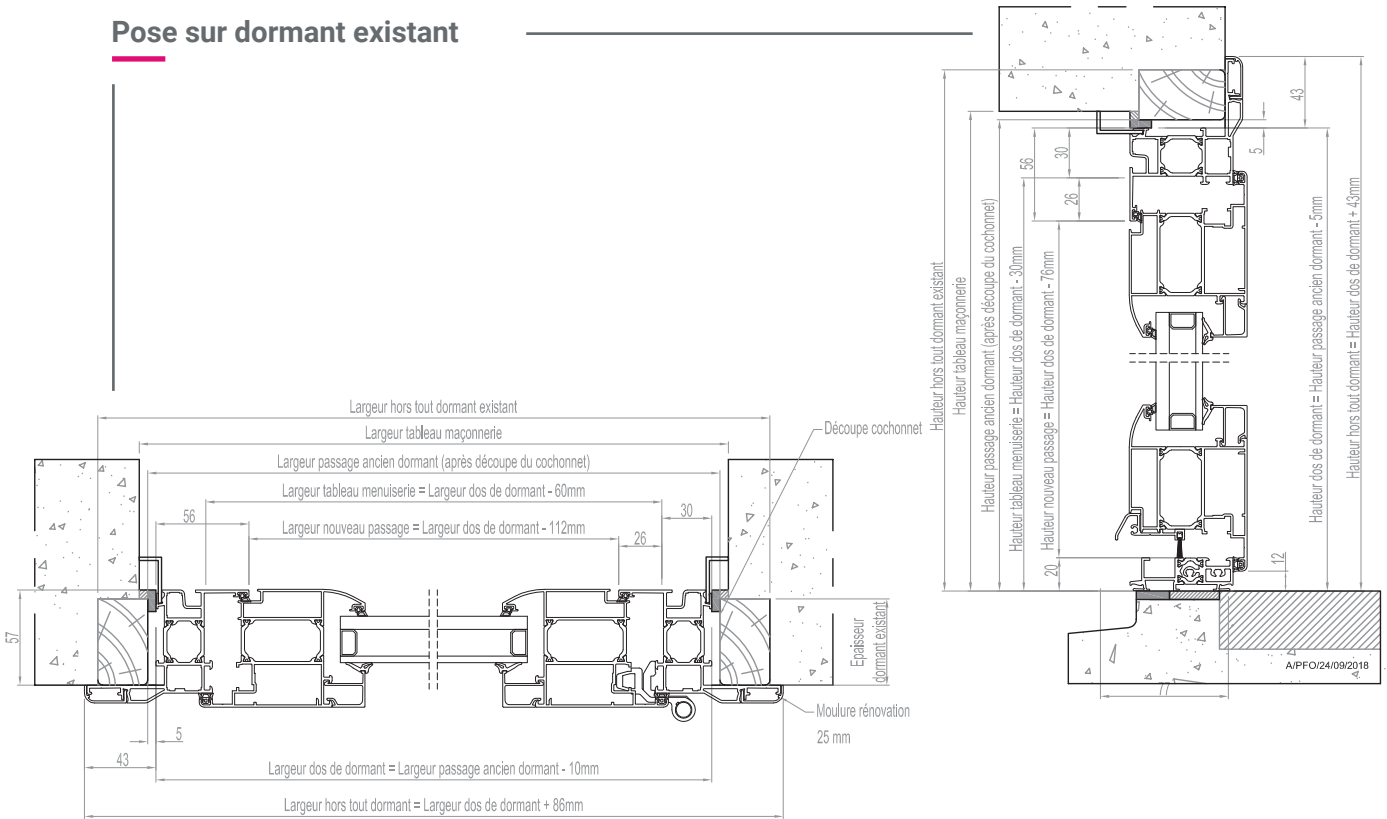

16

Dormant double rainure

Gamme Alu grand vitrage

Ouverture à 90°

